

# NSR15SDW1T1 NSR15SDW1T2

## Dual RF Schottky Diode

These diodes are designed for analog and digital applications, including DC based signal detection and mixing applications.

### Features

- Low Capacitance (<1 pF)
- Low  $V_F$  (390 mV typical @ 1 mA)
- Low  $V_{F\Delta}$  (1 mV typical @ 1 mA)
- Pins 2 and 5 Shorted
- Pb-Free Packages are Available

### Benefits

- Reduced Parasitic Losses
- Accurate Signal Measurement
- Reduced Cross Talk

### MAXIMUM RATINGS

Rating	Symbol	Max	Unit
Peak Reverse Voltage	$V_R$	15	V
Forward Current	$I_F$	30	mA
Operating and Storage Temperature Range	$T_J, T_{stg}$	-65 to +150	°C
ESD Rating: Class 1 per Human Body Model Class A per Machine Model			

### THERMAL CHARACTERISTICS

Characteristic	Symbol	Value	Unit
Maximum Thermal Resistance Junction-to-Ambient	$R_{\theta JA}$	500	°C/W

Stresses exceeding Maximum Ratings may damage the device. Maximum Ratings are stress ratings only. Functional operation above the Recommended Operating Conditions is not implied. Extended exposure to stresses above the Recommended Operating Conditions may affect device reliability.



**ON Semiconductor®**

<http://onsemi.com>

## RF SCHOTTKY BARRIER DIODES 15 VOLTS, 30 mA

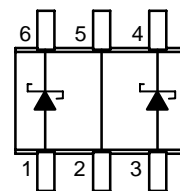

SC-88  
CASE 419B  
STYLE 21

### MARKING DIAGRAM

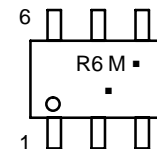

R6 = Specific Device Code  
M = Date Code  
▪ = Pb-Free Package

(Note: Microdot may be in either location)

### ORDERING INFORMATION

Device	Package	Shipping†
NSR15SDW1T1	SC-88	3000/Tape & Reel
NSR15SDW1T1G	SC-88 (Pb-Free)	3000/Tape & Reel
NSR15SDW1T2	SC-88	3000/Tape & Reel
NSR15SDW1T2G	SC-88 (Pb-Free)	3000/Tape & Reel
NSR15SDW1T4	SC-88	10,000/Tape & Reel
NSR15SDW1T4G	SC-88 (Pb-Free)	10,000/Tape & Reel

†For information on tape and reel specifications, including part orientation and tape sizes, please refer to our Tape and Reel Packaging Specifications Brochure, BRD8011/D.

# NSR15SDW1T1 NSR15SDW1T2

## ELECTRICAL CHARACTERISTICS

Characteristic	Symbol	Min	Typ	Max	Unit
Breakdown Voltage ( $I_R = 10 \mu\text{A}$ )	$V_{BR}$	15	20	-	V
Reverse Leakage ( $V_R = 1 \text{ V}$ )	$I_R$	-	2	50	nA
Forward Voltage ( $I_F = 1 \text{ mA}$ )	$V_{F1}$	-	390	415	mV
Forward Voltage ( $I_F = 10 \text{ mA}$ )	$V_{F2}$	-	530	680	mV
Delta $V_F$ ( $I_F = 1 \text{ mA}$ , All Diodes)	$\Delta V_F$	-	1	15	mV
Capacitance ( $V_F = 0 \text{ V}$ , $f = 1 \text{ MHz}$ )	$C_T$	-	0.8	1	pF

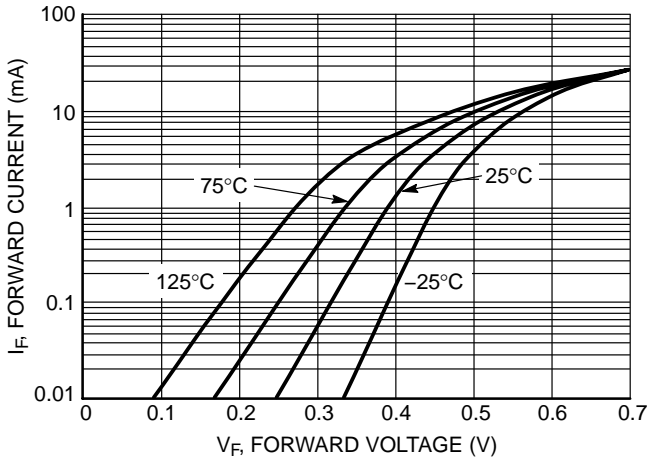

Figure 1. Forward Current versus Forward Voltage at Temperatures

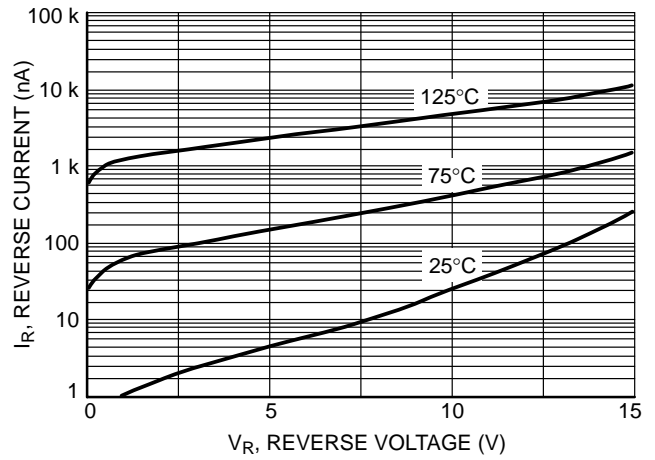

Figure 2. Reverse Current versus Reverse Voltage

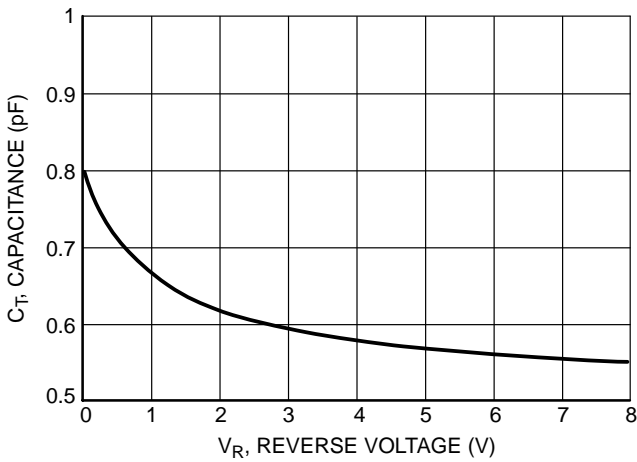

Figure 3. Total Capacitance versus Reverse Voltage

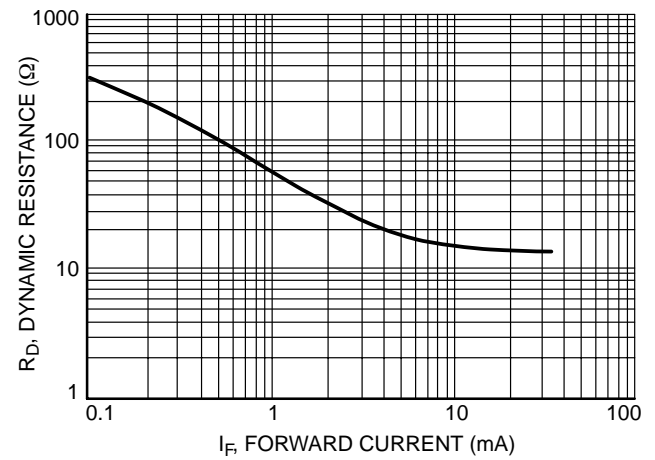

Figure 4. Dynamic Resistance versus Forward Current

# NSR15SDW1T1 NSR15SDW1T2

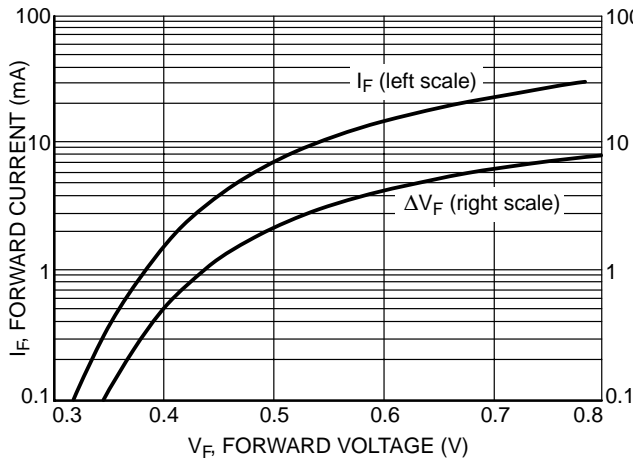

Figure 5. Typical  $V_F$  Match at Mixer Bias Levels

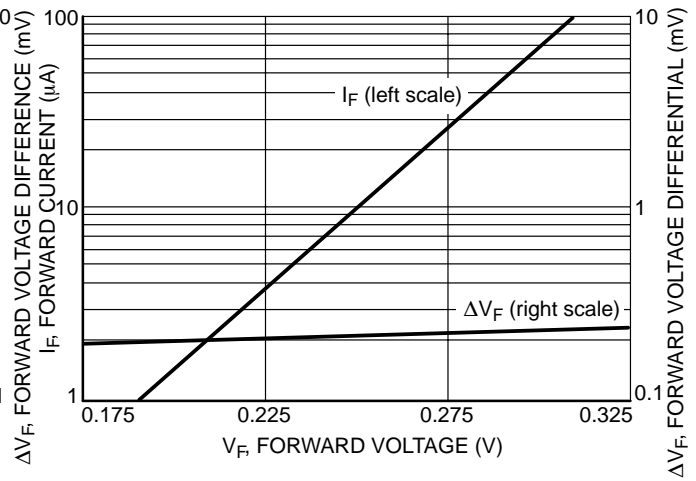

Figure 6. Typical  $V_F$  Match at Detector Bias Levels

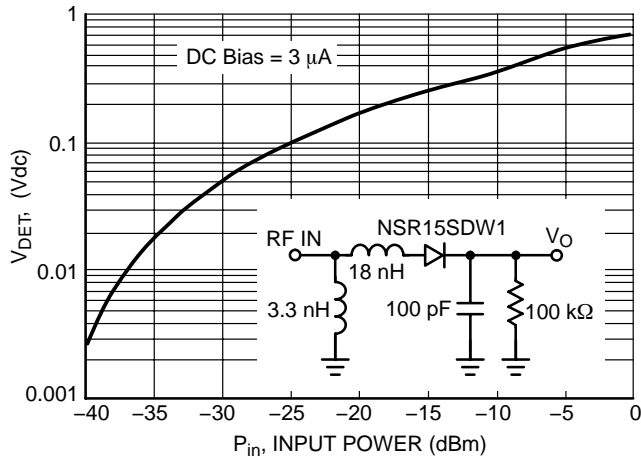

Figure 7. Typical Output Voltage versus Input Power, Small Signal Detector Operating at 850 MHz

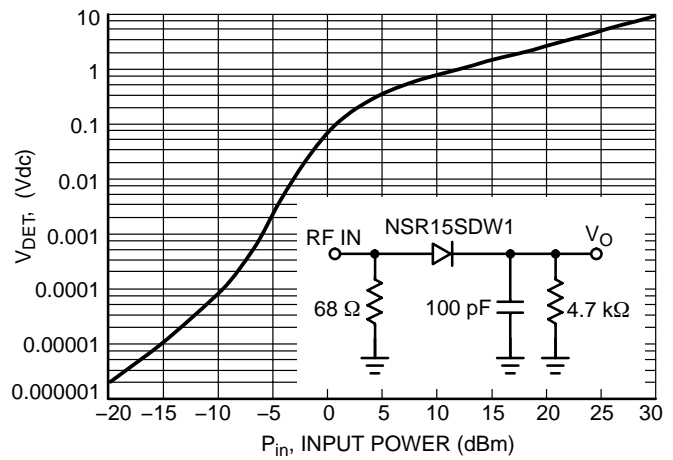

Figure 8. Typical Output Voltage versus Input Power, Large Signal Detector Operating at 915 MHz

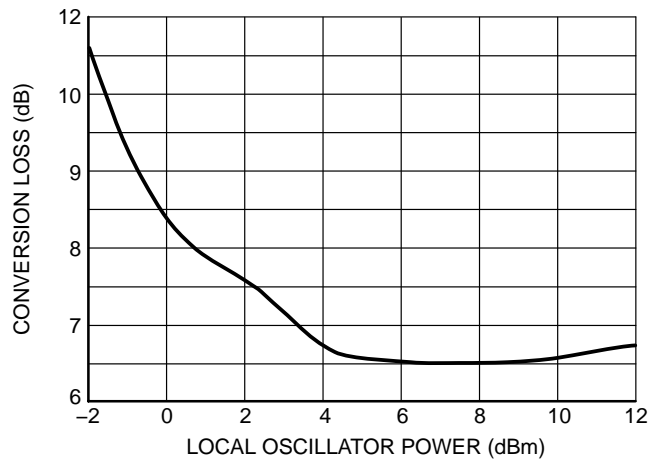
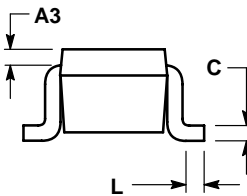
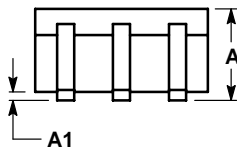
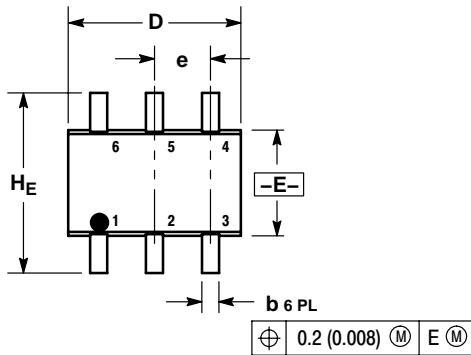

Figure 9. Typical Conversion Loss versus L.O. Drive, 2.0 GHz

# NSR15SDW1T1 NSR15SDW1T2

## PACKAGE DIMENSIONS

SC-88/SC70-6/SOT-363  
CASE 419B-02  
ISSUE W



### NOTES:

1. DIMENSIONING AND TOLERANCING PER ANSI Y14.5M, 1982.
2. CONTROLLING DIMENSION: INCH.
3. 419B-01 OBSOLETE, NEW STANDARD 419B-02.

DIM	MILLIMETERS			INCHES		
	MIN	NOM	MAX	MIN	NOM	MAX
A	0.80	0.95	1.10	0.031	0.037	0.043
A1	0.00	0.05	0.10	0.000	0.002	0.004
A3	0.20 REF			0.008 REF		
b	0.10	0.21	0.30	0.004	0.008	0.012
C	0.10	0.14	0.25	0.004	0.005	0.010
D	1.80	2.00	2.20	0.070	0.078	0.086
E	1.15	1.25	1.35	0.045	0.049	0.053
e	0.65 BSC			0.026 BSC		
L	0.10	0.20	0.30	0.004	0.008	0.012
HE	2.00	2.10	2.20	0.078	0.082	0.086

### STYLE 21:

- PIN 1. ANODE 1
- 2. N/C
- 3. ANODE 2
- 4. CATHODE 2
- 5. N/C
- 6. CATHODE 1

### SOLDERING FOOTPRINT\*

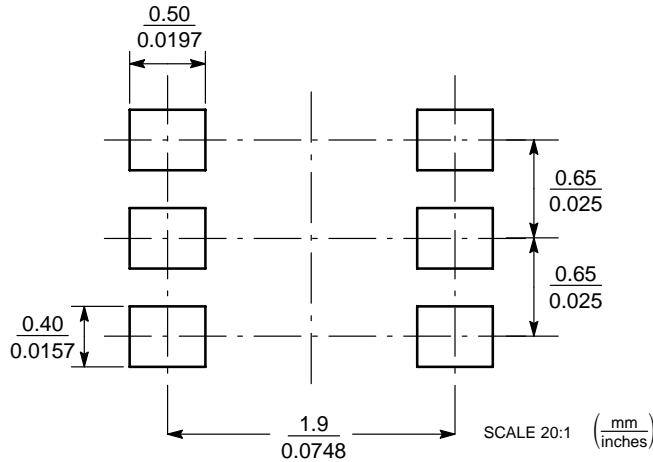

\*For additional information on our Pb-Free strategy and soldering details, please download the ON Semiconductor Soldering and Mounting Techniques Reference Manual, SOLDERRM/D.

ON Semiconductor and are registered trademarks of Semiconductor Components Industries, LLC (SCILLC). SCILLC reserves the right to make changes without further notice to any products herein. SCILLC makes no warranty, representation or guarantee regarding the suitability of its products for any particular purpose, nor does SCILLC assume any liability arising out of the application or use of any product or circuit, and specifically disclaims any and all liability, including without limitation special, consequential or incidental damages. "Typical" parameters which may be provided in SCILLC data sheets and/or specifications can and do vary in different applications and actual performance may vary over time. All operating parameters, including "Typicals" must be validated for each customer application by customer's technical experts. SCILLC does not convey any license under its patent rights nor the rights of others. SCILLC products are not designed, intended, or authorized for use as components in systems intended for surgical implant into the body, or other applications intended to support or sustain life, or for any other application in which the failure of the SCILLC product could create a situation where personal injury or death may occur. Should Buyer purchase or use SCILLC products for any such unintended or unauthorized application, Buyer shall indemnify and hold SCILLC and its officers, employees, subsidiaries, affiliates, and distributors harmless against all claims, costs, damages, and expenses, and reasonable attorney fees arising out of, directly or indirectly, any claim of personal injury or death associated with such unintended or unauthorized use, even if such claim alleges that SCILLC was negligent regarding the design or manufacture of the part. SCILLC is an Equal Opportunity/Affirmative Action Employer. This literature is subject to all applicable copyright laws and is not for resale in any manner.

### PUBLICATION ORDERING INFORMATION

**LITERATURE FULFILLMENT:**  
Literature Distribution Center for ON Semiconductor  
P.O. Box 5163, Denver, Colorado 80217 USA  
**Phone:** 303-675-2175 or 800-344-3860 Toll Free USA/Canada  
**Fax:** 303-675-2176 or 800-344-3867 Toll Free USA/Canada  
**Email:** orderlit@onsemi.com

**N. American Technical Support:** 800-282-9855 Toll Free  
USA/Canada  
**Europe, Middle East and Africa Technical Support:**  
Phone: 421 33 790 2910  
**Japan Customer Focus Center**  
Phone: 81-3-5773-3850

**ON Semiconductor Website:** [www.onsemi.com](http://www.onsemi.com)  
**Order Literature:** <http://www.onsemi.com/orderlit>  
For additional information, please contact your local Sales Representative